

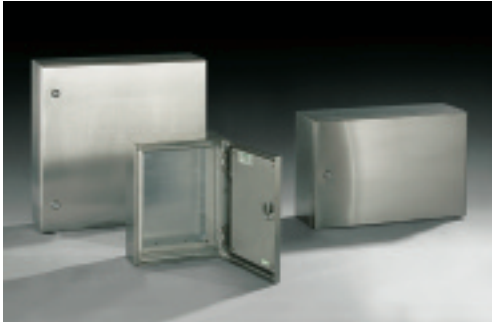

CE STX

stainless steel boxes



characteristics

Enclosure and door manufactured from AISI 304 stainless steel (AISI 316 on request).
Mounting plate manufactured from 2.5mm sendzimir sheet steel.
Hinge in stainless steel.

composition

Box complete with:

- mounting plate
- locking system body in zinc alloy and lever in stainless steel with Ø 3mm double bar key
- package with hardware for earth connection and screws to mounting plate.

conformity and approval



protection degree

- IP 65 complying with EN50298; EN60529 for box with single blank door
- IP 55 complying with EN50298; EN60529 for box with double blank door
- type 12, 4, 4X complying with UL508A; UL50
- impact resistance IK10 complying with EN50298; EN50102.

box with single blank door

code		B	A	P	C	D	E	F	weight kg
mod.	art.								
CESTX2	315	200	300	150	150	250	*	219	6
CESTX3	415	300	400	150	250	350	215	319	9,5
CESTX3	420	300	400	200	250	350	215	319	11
CESTX4	315	400	300	150	350	250	315	219	9,5
CESTX4	420	400	400	200	350	350	315	319	13,5
CESTX4	520	400	500	200	350	450	315	419	15,5
CESTX4	620	400	600	200	350	550	315	519	18
CESTX5	520	500	500	200	450	450	415	419	18
CESTX5	725	500	700	250	450	650	415	619	27
CESTX6	420	600	400	200	550	350	315	519	17,3
CESTX6	620	600	600	200	550	550	515	519	24,5
CESTX6	625	600	600	250	550	550	515	519	27
CESTX6	630	600	600	300	550	550	515	519	30
CESTX6	820	600	800	200	550	750	515	719	31
CESTX6	825	600	800	250	550	750	515	719	34
CESTX6	830	600	800	300	550	750	515	719	37
CESTX6	1230	600	1200	300	550	1150	515	1119	54
CESTX8	830	800	800	300	750	750	715	719	48
CESTX8	1030	800	1000	300	750	950	715	919	58
CESTX8	1230	800	1200	300	750	1150	715	1119	67

* B=200 M6 studs welded only on the hinge side.

To order a stainless steel enclosure in high grade AISI 316, please add H to the catalogue number. E.g.: CESTX2-315H.
Please contact CE-TEK sales department for minimum order quantities.

box with double blank door

code		B	A	C	D	E	F	G	G'	I	I'	weight kg
mod.	art.											
CESTX10	1030	1000	1000	935	950	954	954	415	375	919	919	69
CESTX10	1230	1000	1200	935	1150	954	1154	415	375	1119	1119	80

To order a stainless steel enclosure in high grade AISI 316, please add H to the catalogue number. E.g.: CESTX10-1030H.

stainless steel boxes

BOX WITH SINGLE BLANK DOOR

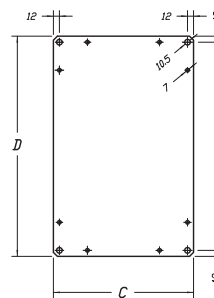
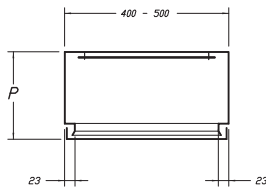
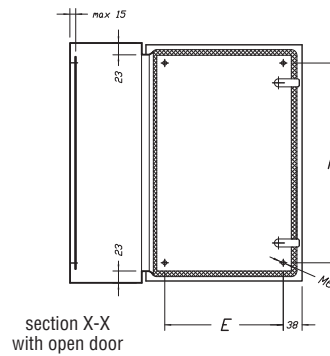
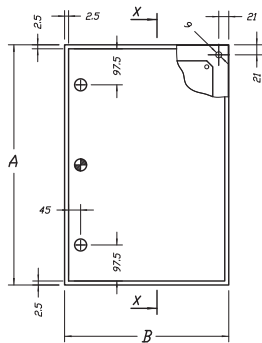

⊕ central lock for A<600

BOX WITH DOUBLE BLANK DOOR

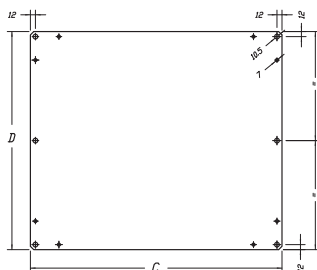
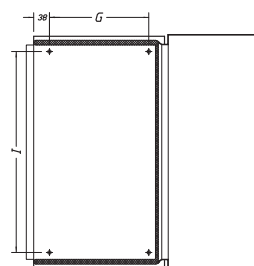
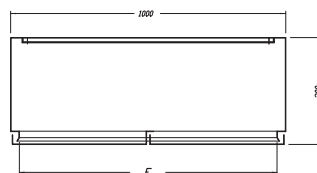
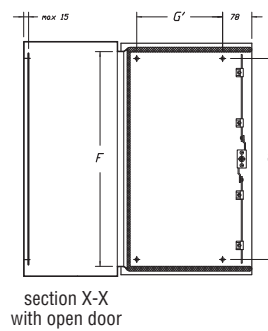
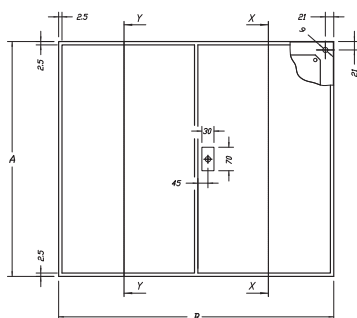



stainless steel boxes with glazed door



STAINLESS STEEL BOX WITH GLAZED DOOR - CE STPX

characteristics

Enclosure manufactured in AISI 304 material (AISI 316 on request).
 Door manufactured in AISI 304 material with plexiglas viewing window. AISI 316 on request.
 Mounting plate manufactured in 2.5mm zinc-plated steel.
 Hinges in stainless steel.

composition

Box complete with:

- mounting plate
- gland plate with sealing gasket
- lock system with body in zinc alloy
- ø 3 mm double bar key
- screws for earthing and mounting accessories.

conformity and approval



protection degree

- IP 55 complying with EN50298; EN60529
- type 12 complying with UL508A; UL50
- impact resistance IK10 complying with EN50298; EN50102.

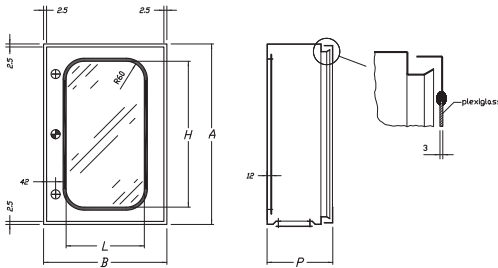

⊕ central lock for A<600

dimensions					code	
B	A	L	H	P	mod.	art.
300	400	160	285	200	STPX3	420
400	500	260	385	200	STPX4	520
400	600	260	485	200	STPX4	620
500	700	360	585	250	STPX5	725
600	800	460	685	200	STPX6	820
600	800	460	685	250	STPX6	825

To order a stainless steel enclosure in high grade AISI 316, please add H to the catalogue number.
 E.g.: CESTPX4-620H.

stainless steel accessories



inner door kit

STAINLESS STEEL INNER DOOR STP01 ... X

characteristics

Frame and door manufactured from 1.5mm AISI 304 material (AISI 316 on request).

composition

Supply includes:

- frame
- door
- lock system with body in zinc alloy
- ø 3 mm double bar key
- mounting accessories.

protection degree

- external: same of the box
- internal: IP 20.

dimensions		code	
L	H	mod.	art.
300	400	STP01	34X
400	500	STP01	45X
400	600	STP01	46X
500	700	STP01	57X
600	800	STP01	68X

To order a stainless steel enclosure in high grade AISI 316, please add H to the catalogue number.
 E.g.: STP01-46XH.



stainless steel accessories

STAINLESS STEEL MODULAR KIT

characteristics

Frame manufactured from 1.5mm AISI 304 material.
 Front panels manufactured from 1.5mm AISI 304 material.
 AISI 316 available on request.

composition

Supply includes:

- frame
- front panel with modular slot complete with mounting accessories and captive screws
- zinc plated DIN rails
- mounting accessories.

protection degree

- external: same of the box
- internal: IP 1X.



dimensions		code	
width	depth	mod.	art.
400	600	MDSTX4	600
600	800	MDSTX6	800

To order a stainless steel enclosure in high grade AISI 316, please add H to the catalogue number.
 E.g.: MDTX4-600H.

STAINLESS STEEL RAIN CANOPY TTX

To protect against direct water entry.
 Manufactured from 1.5mm AISI 304 stainless steel material.
 AISI 316 available on request.

For outdoor installations, the cabinets can be supplied with a stainless steel roof cover.

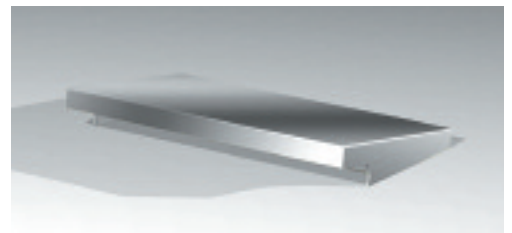

dimensions		code	
width	depth	mod.	art.
400	200	TTX1	04
500	200	TTX1	05
500	250	TTX2	05
600	250	TTX1	06
800	300	TTX2	08

To order a stainless steel enclosure in high grade AISI 316, please add H to the catalogue number.
 E.g.: TTX1-04H.

STAINLESS STEEL WALL MOUNTING BRACKETS

SDWCX

Manufactured in 2.5mm stainless steel.
 Supply includes: 4 pieces.

code	
mod.	art.
SDWCX	010

